



The Backcountry Hut Company

© 2024 The Backcountry Hut Company



System 02

240508



The Backcountry Hut Company



Surf Hut / Tofino BC



The Backcountry Hut Company

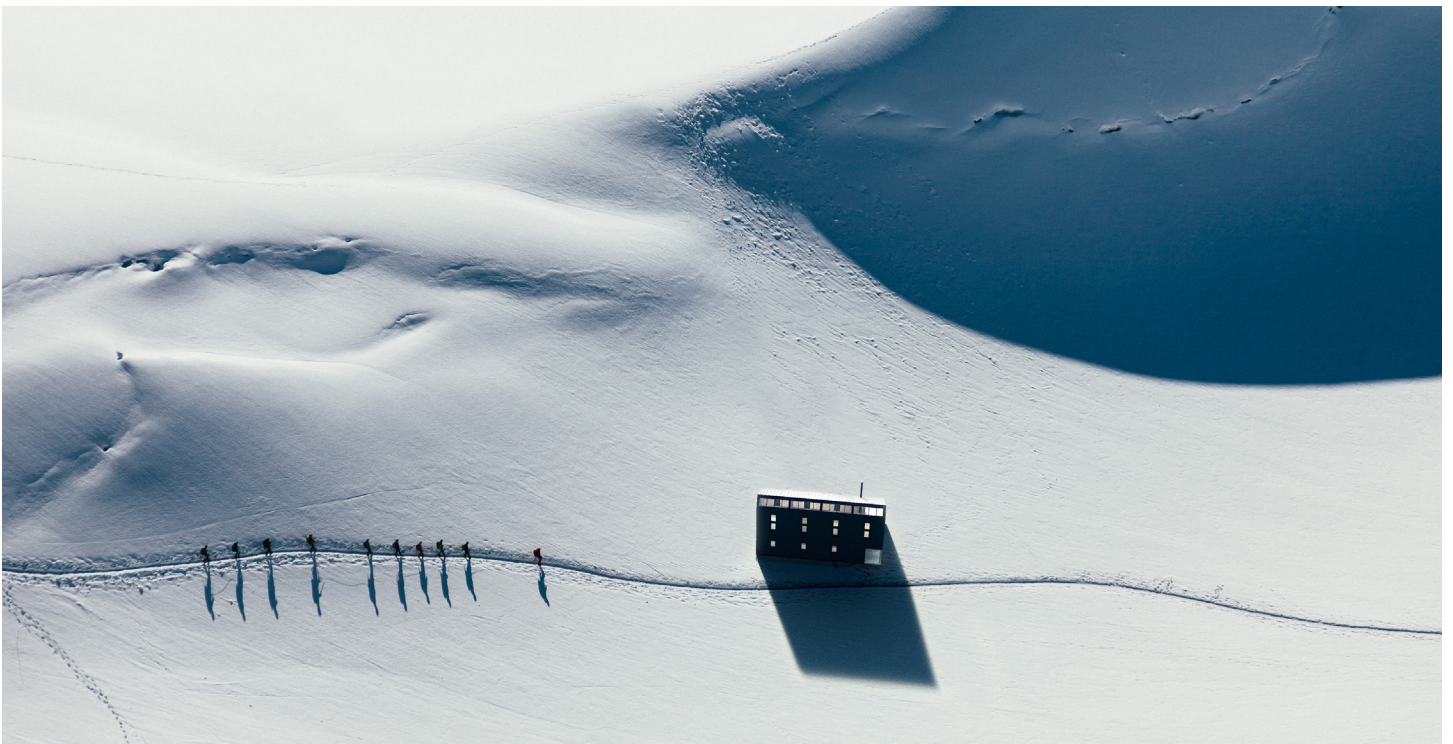

Alpine Hut

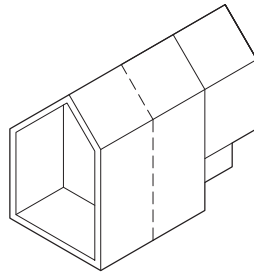
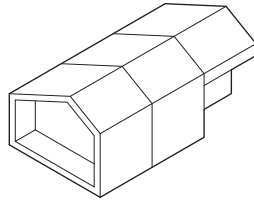
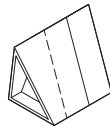

Our Mission

The Backcountry Hut Company was founded in 2015, born from a deep appreciation of the outdoors and a desire to put down roots in the places we seek adventure.

We specialize in compact modernist recreational structures, crafted to rigorous standards, designed to leave a minimal impact on our environment. Our collection of prefabricated, flat-packed building systems help individuals and organizations turn dreams into destinations, and can be configured to meet a variety of uses, landscapes, and lifestyle needs.

Inspired by simplicity and the quest to provide outstanding design and value, our systems are developed with user participation in mind - with an emphasis on self-assembly and communal construction. The result is a prefabricated kit-of-parts building system that ships directly to site and can be assembled in a fraction of the time of a traditional construction process.

Whether your adventures call you to the mountains, the coast, or somewhere in between, you need a place to call home at the end of the day.



Upper Floor

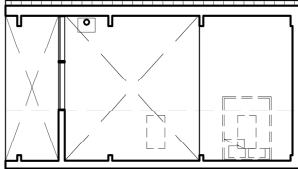

Main Floor

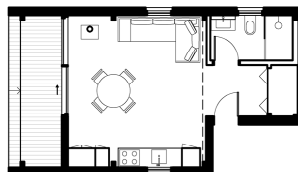
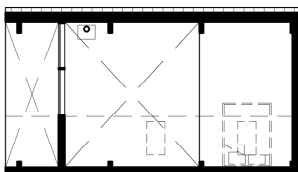
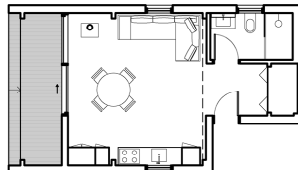
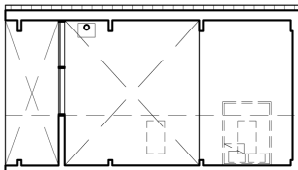
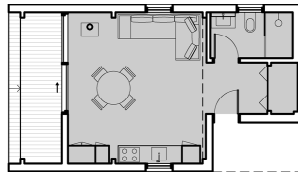
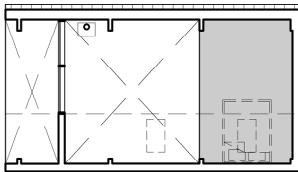
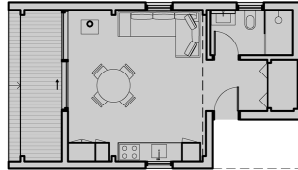
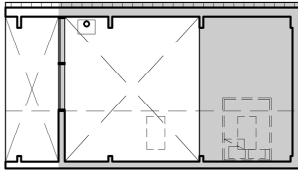
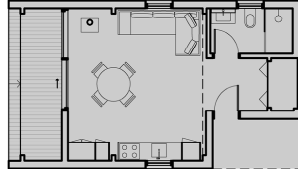

Definitions

Building Footprint

The floor area covered by all roofs and soffits. This includes both interior and exterior space.

Gross Built Area

The built area including all enclosed floors and lofts measured from the exterior face of building walls. Covered exterior decks are included. Open-to-below spaces are excluded. Stairs are counted on one level.

Interior Layout Area

The area including all enclosed floors and lofts measured from the inside face of building walls and excluding interior partition walls and structure. Covered decks are excluded. Hallways are included. Open to below spaces are excluded. Stairs are counted on one level.

Exterior Deck

The area of all exterior covered decks and porches.

Interior Layouts

Interior layouts are provided for reference only and illustrate recommendations for functional program and use.



The Backcountry Hut Company

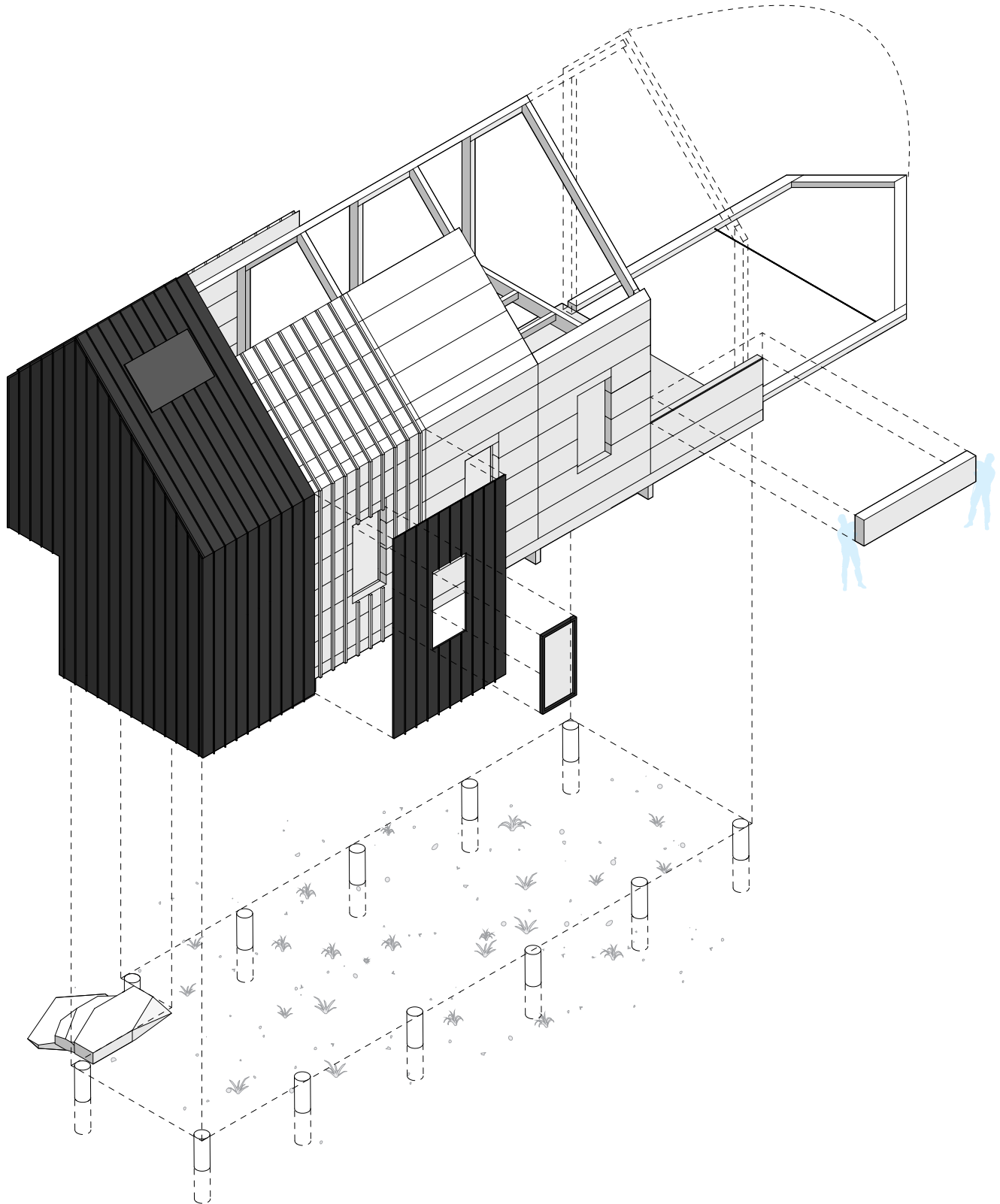

Assembly Diagram | System 02



The Backcountry Hut Company

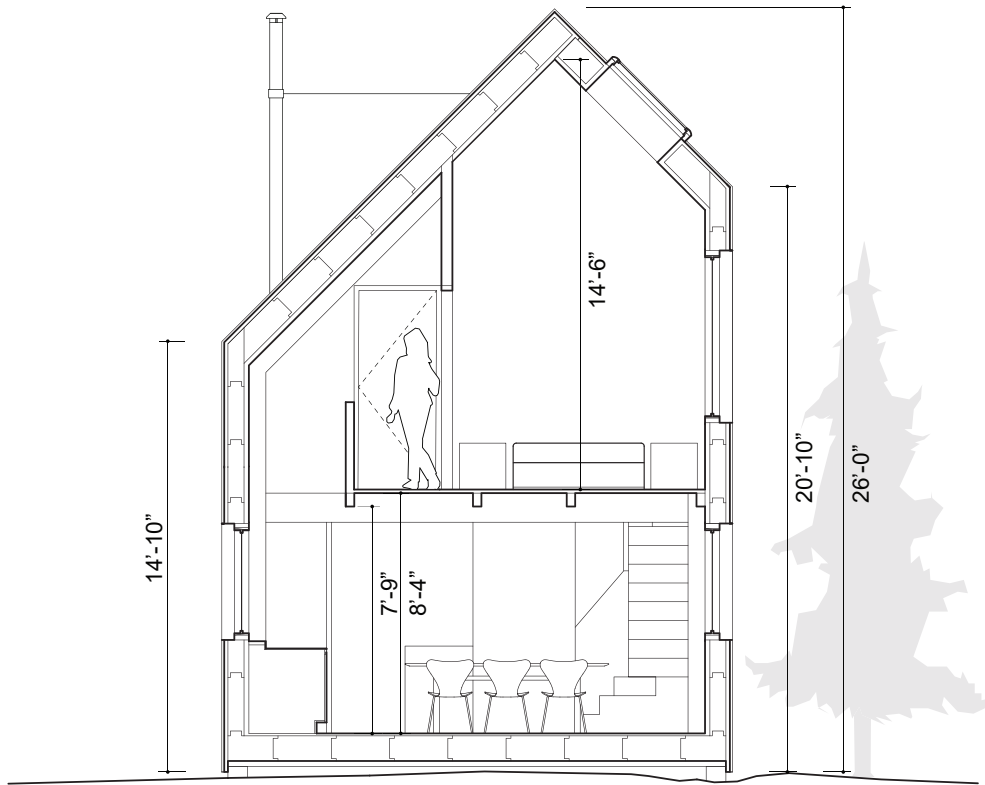

Cross Section | System 02



The Backcountry Hut Company

2 Module

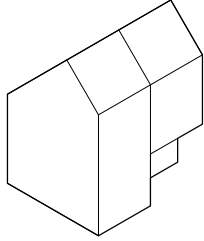

3 Module

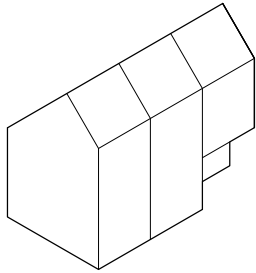

4 Module

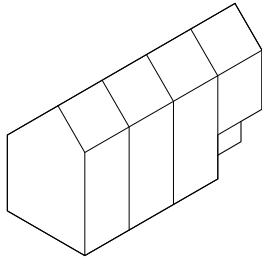

+ Deck

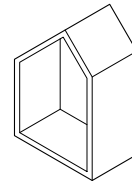

5 Module
+ Deck

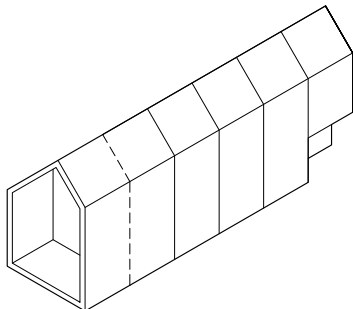

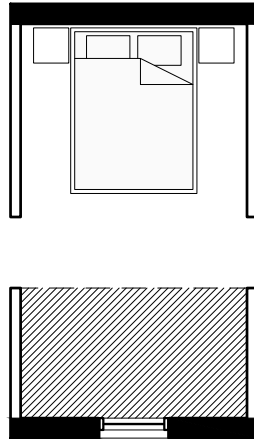

Flex Bay System

Flex Bays are flexible layout options to help you envision customization and possibilities to make the most of your space. We recommend discussing the technical details of your Flex Bay ideas with your contractor or BHC to ensure the best results.

Storage

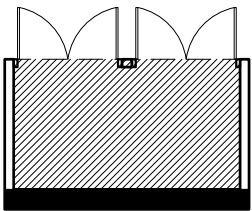

Storage Room

Ensuite

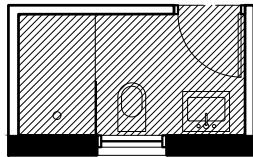

1st Floor Bathroom

Leisure

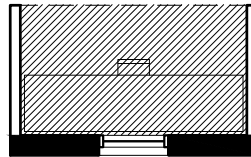

Study

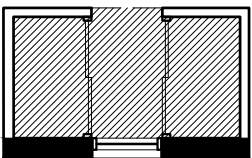

Dressing Room

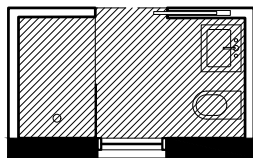

Bathroom

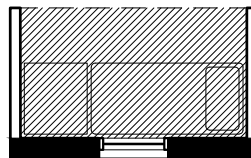

Daybed

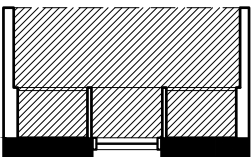

Closet + Bench

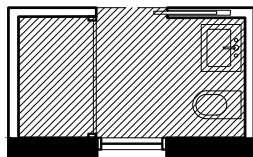

1/2 Bath + Closet

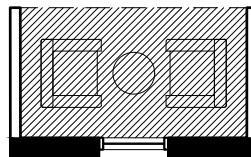

Lounge

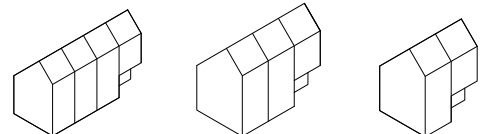



The Backcountry Hut Company

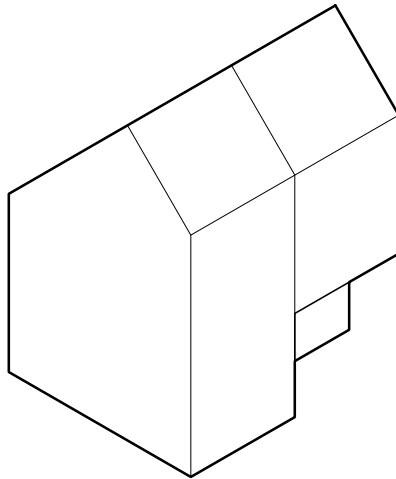

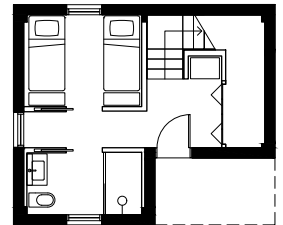
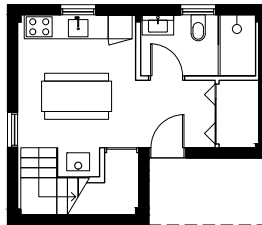
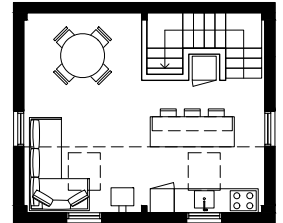
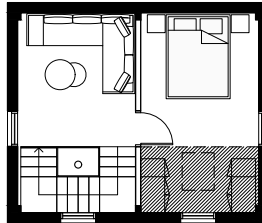

B

C

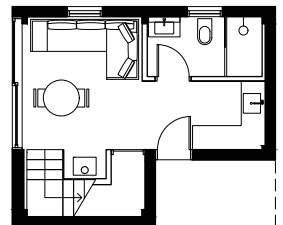
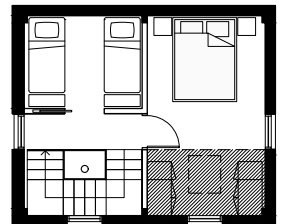

under development | D

Limited Compatibility with
BHC Interior Specification Guide

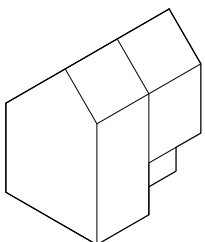



Flex Bays

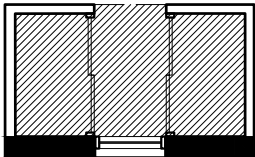

Closet + Bench

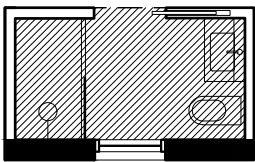

Bathroom

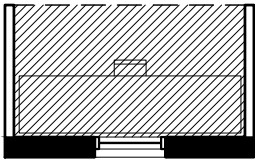

Study

Refer to flex bay appendix for complete selection of flex bay options

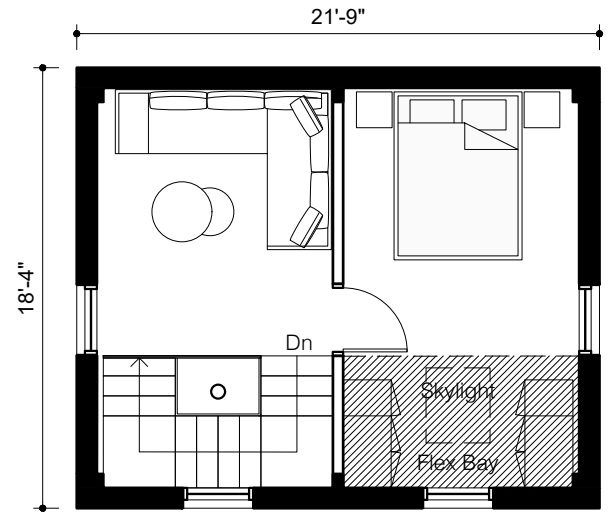

2nd Floor

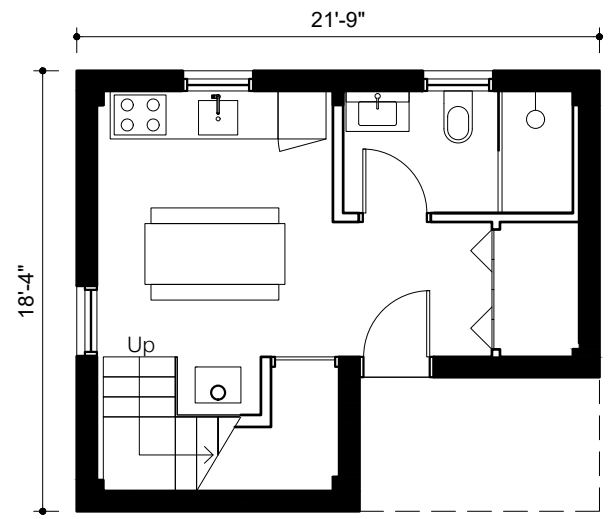

1st Floor

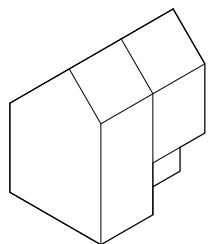

System 02 | 2 Module | B

Gross Built Area:	691 sq ft
Building Footprint:	400 sq ft
Interior Layout Area:	548 sq ft
Deck Area:	0 sq ft

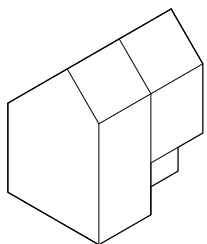
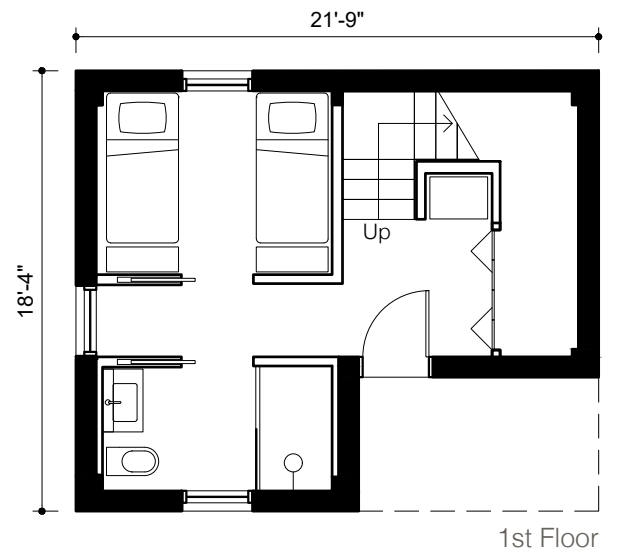
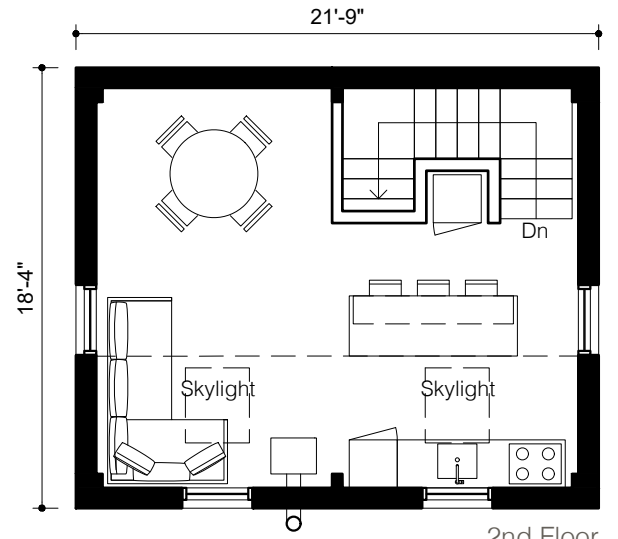

System 02 | 2 Module | C

Gross Built Area:	700 sq ft
Building Footprint:	400 sq ft
Interior Layout Area:	550 sq ft
Deck Area:	0 sq ft



Flex Bays

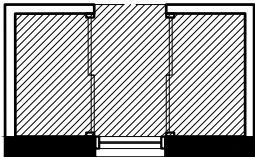

Closet + Bench

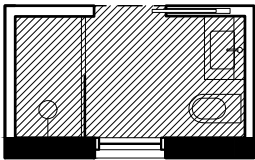

Bathroom

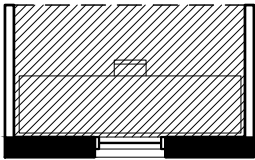

Study

Refer to flex bay appendix for complete selection of flex bay options

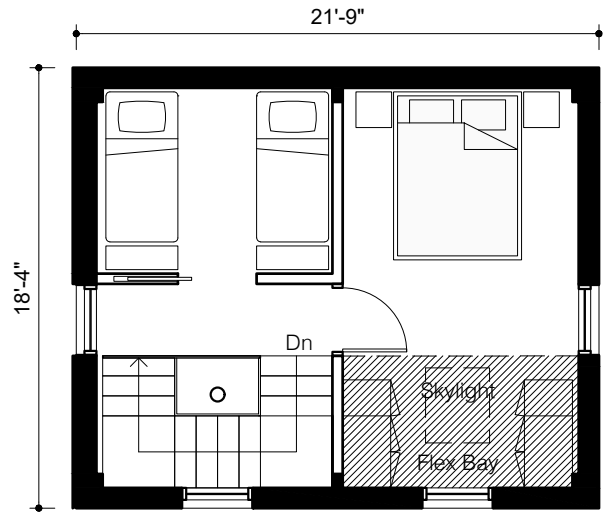

2nd Floor

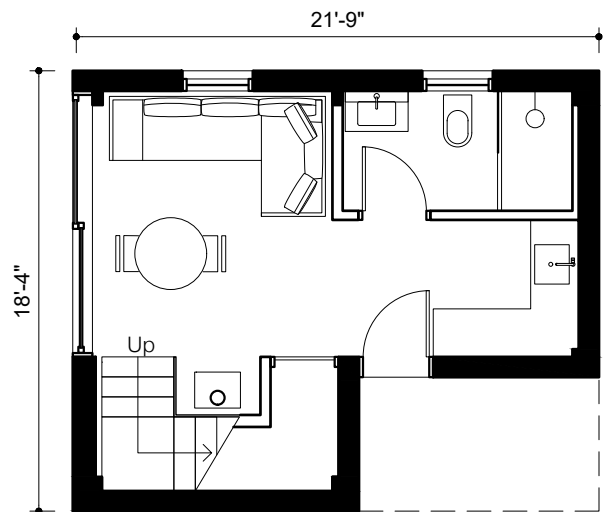

1st Floor

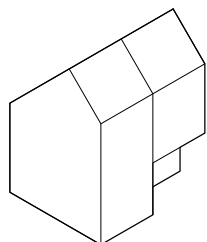

under development

Limited Compatibility with BHC Interior Specification Guide

System 02 | 2 Module | D

Gross Built Area:	691 sq ft
Building Footprint:	400 sq ft
Interior Layout Area:	547 sq ft
Deck Area:	0 sq ft



The Backcountry Hut Company

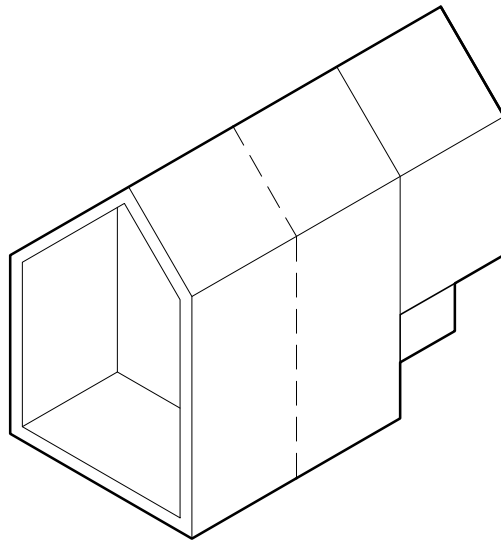



The Backcountry Hut Company



F

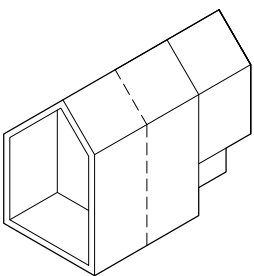

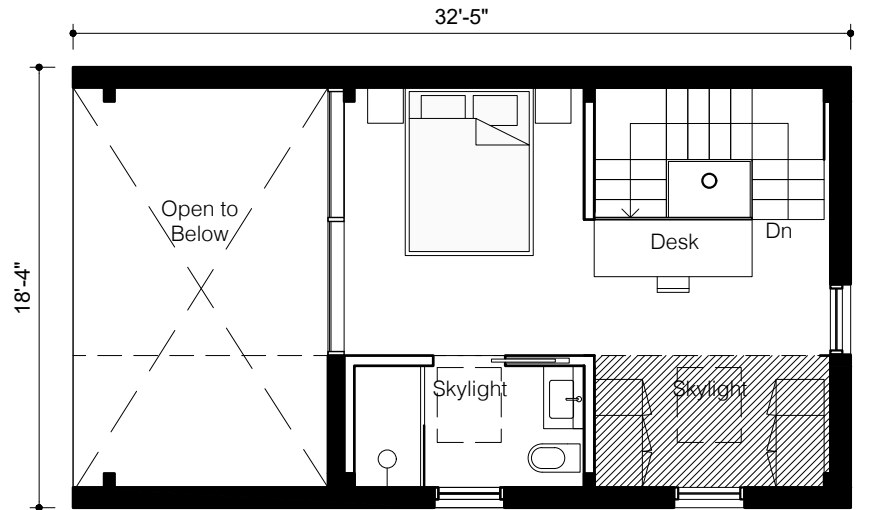

2nd Floor

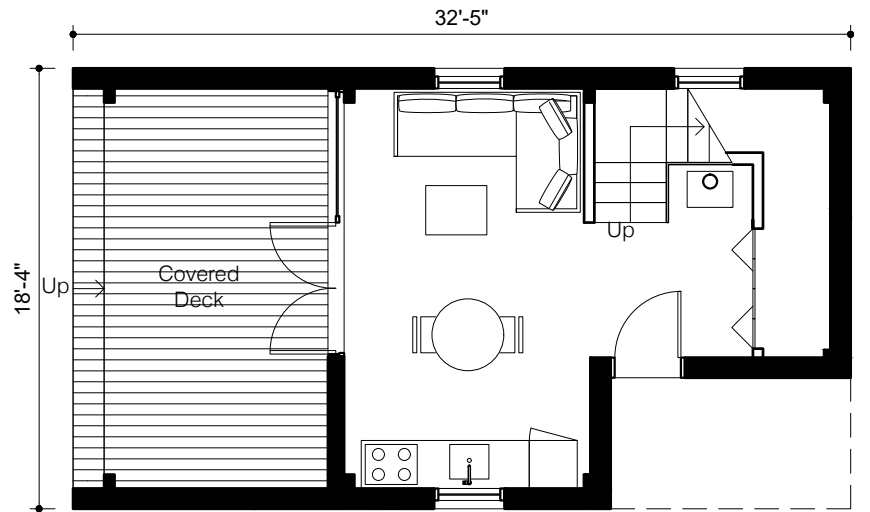

1st Floor

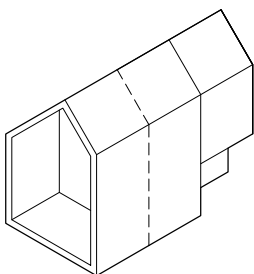

System 02 | 2 Module + Deck | F

Gross Built Area:	872 sq ft
Building Footprint:	595 sq ft
Interior Layout Area:	549 sq ft
Deck Area:	174 sq ft



The Backcountry Hut Company

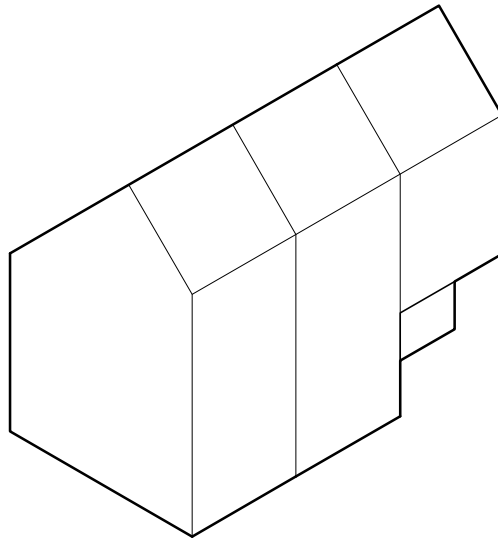

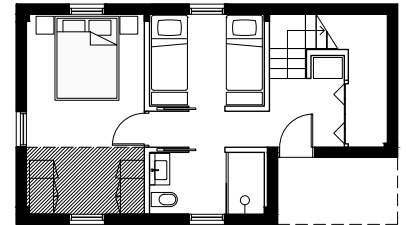
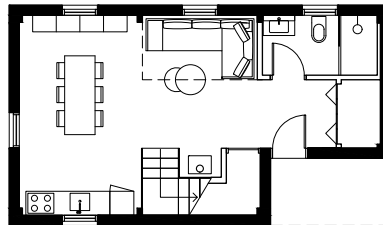
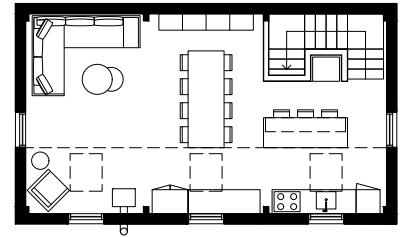
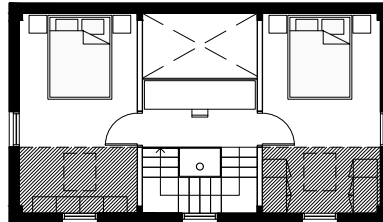

B

C

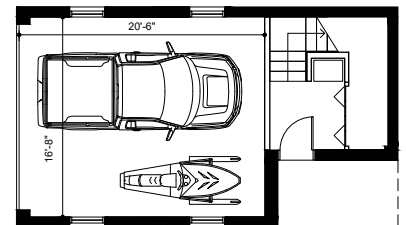
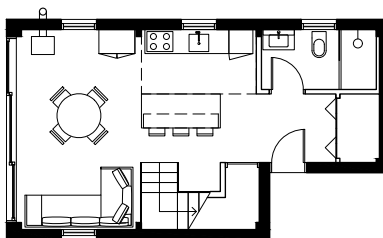
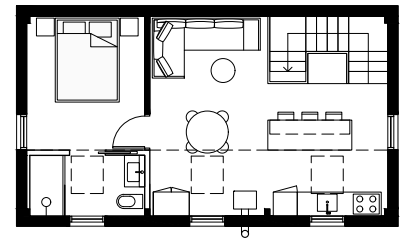

D

under development | G

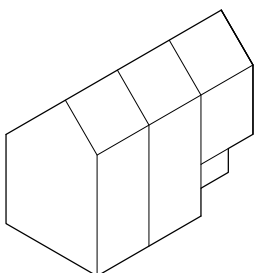



The Backcountry Hut Company

Flex Bays

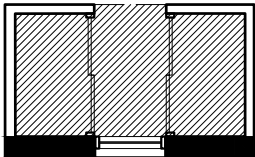

Closet + Bench

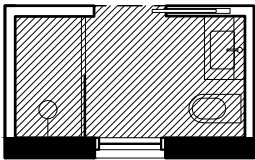

Bathroom

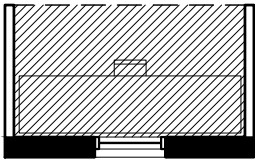

Study

Refer to flex bay appendix for complete selection of flex bay options

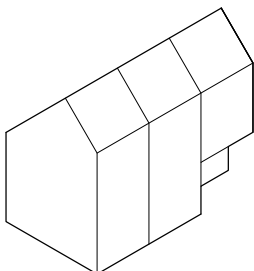
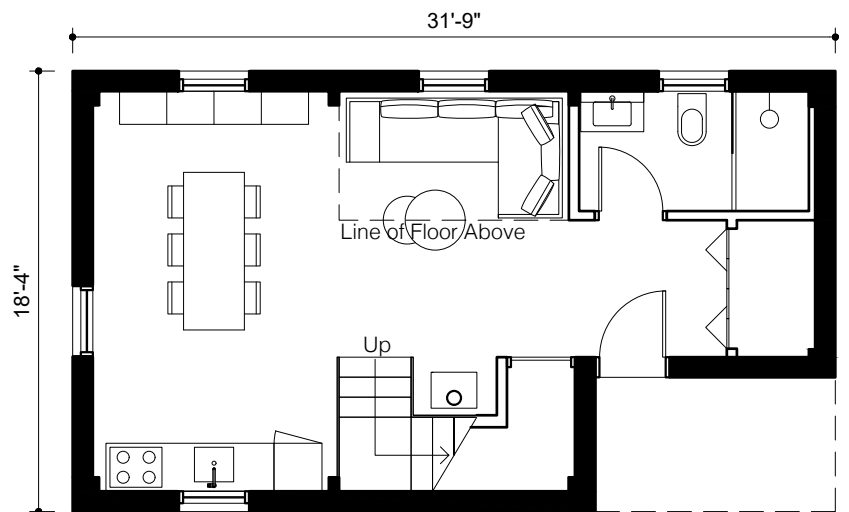
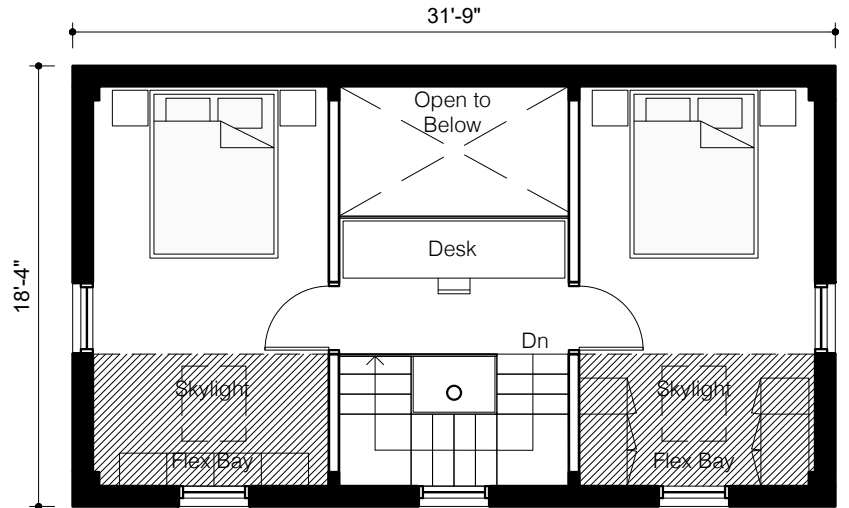

System 02 | 3 Module | B

Gross Built Area:	1007 sq ft
Building Footprint:	584 sq ft
Interior Layout Area:	824 sq ft
Deck Area:	0 sq ft



The Backcountry Hut Company

Flex Bays

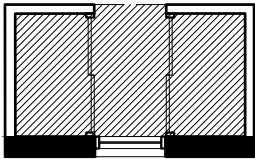

Closet + Bench

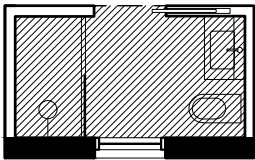

Bathroom

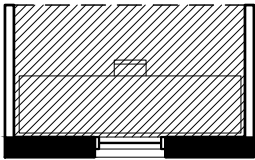

Study

Refer to flex bay appendix for complete selection of flex bay options

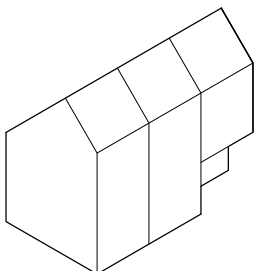
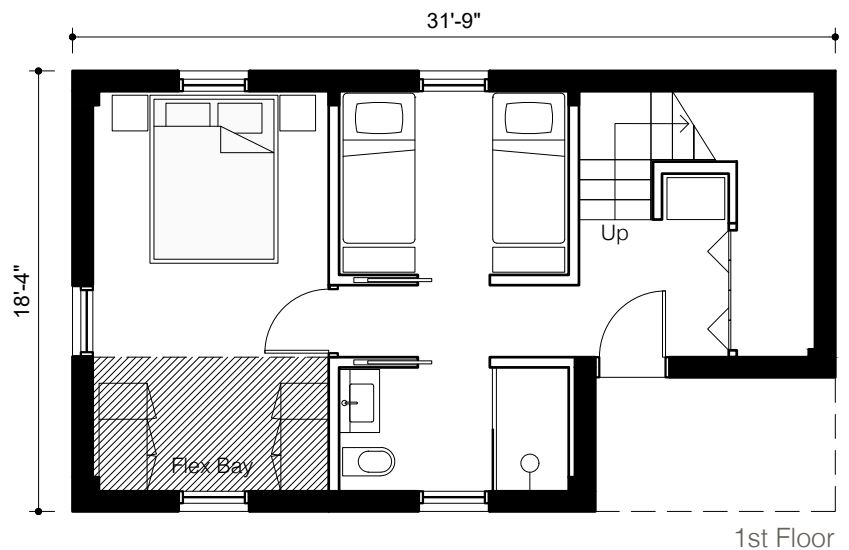
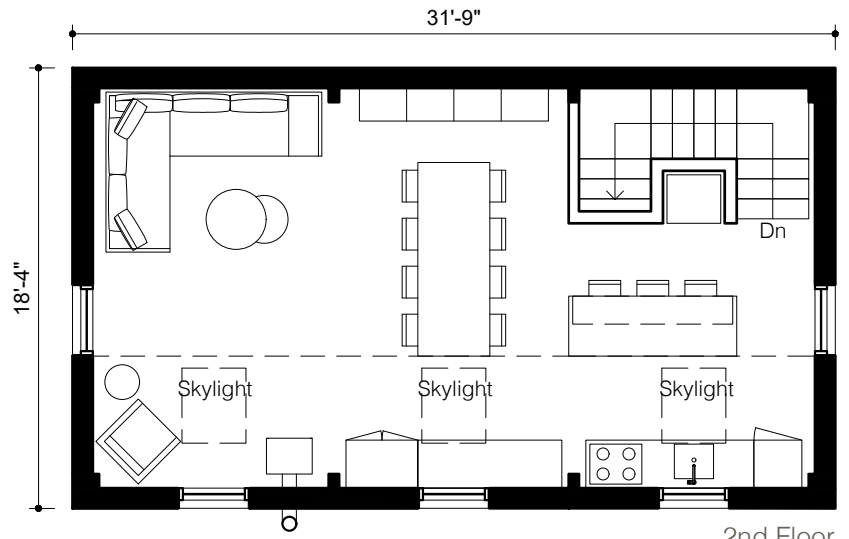

System 02 | 3 Module | C

Gross Built Area:	1067 sq ft
Building Footprint:	584 sq ft
Interior Layout Area:	876 sq ft
Deck Area:	0 sq ft



The Backcountry Hut Company

Flex Bays

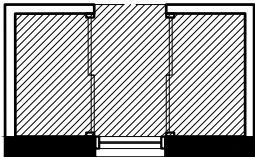

Closet + Bench

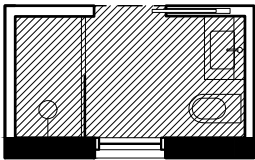

Bathroom

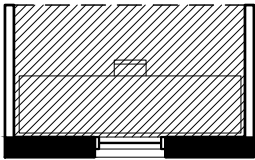

Study

Refer to flex bay appendix for complete selection of flex bay options

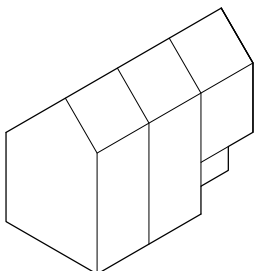
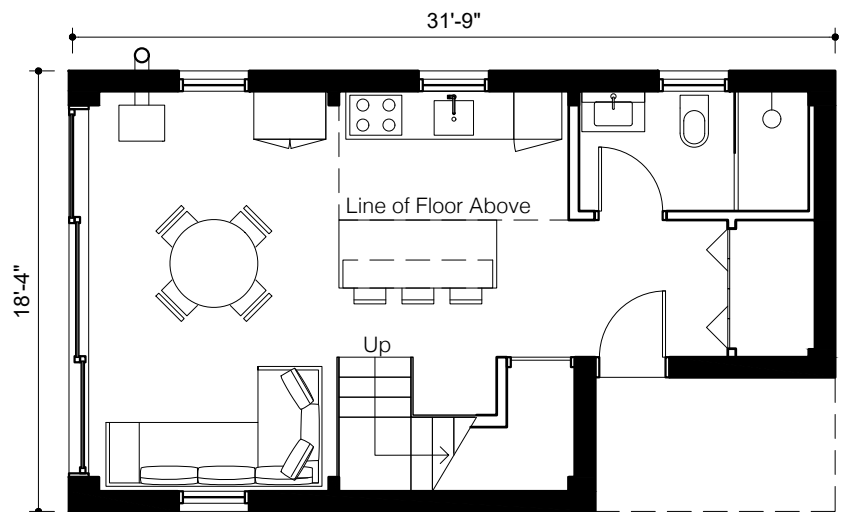
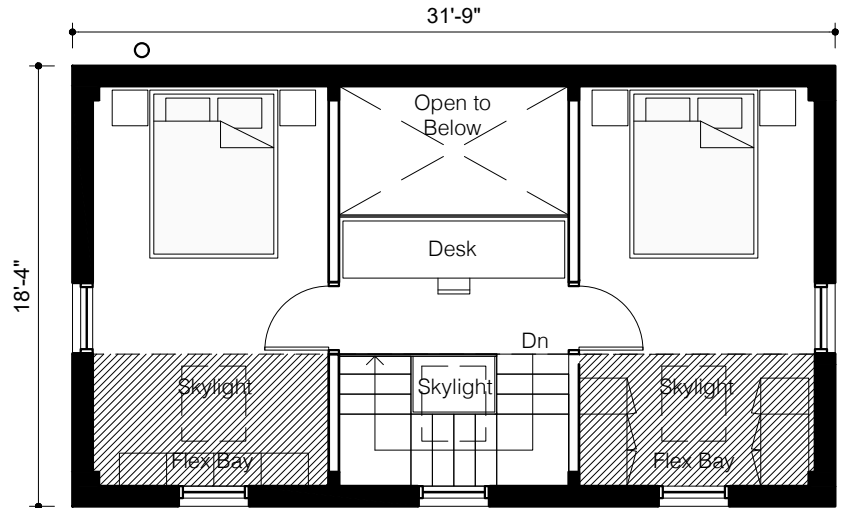

System 02 | 3 Module | D

Gross Built Area:	1007 sq ft
Building Footprint:	584 sq ft
Interior Layout Area:	825 sq ft
Deck Area:	0 sq ft

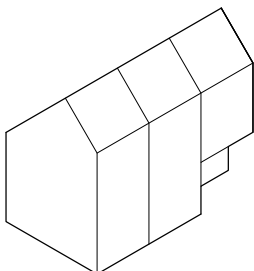
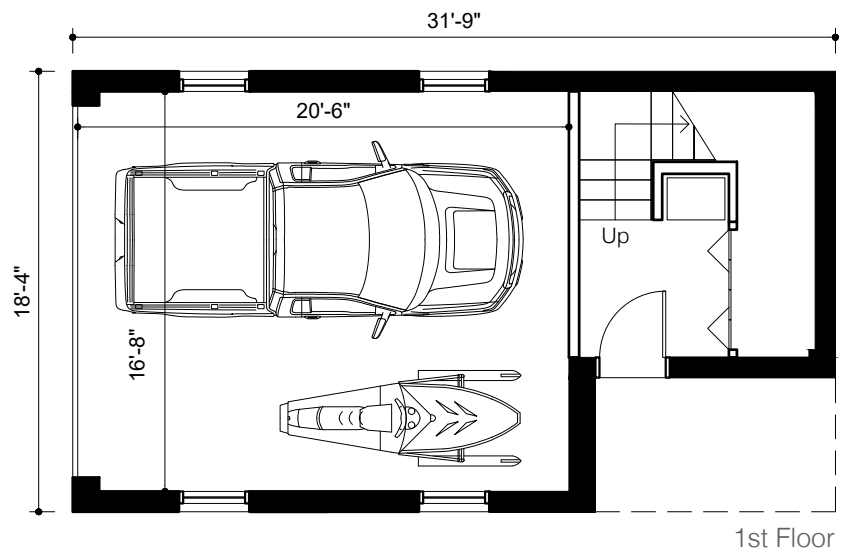
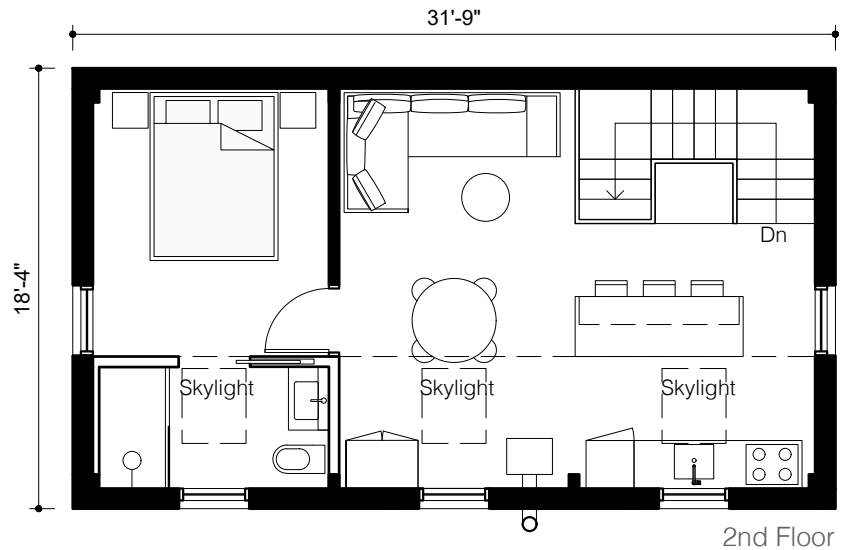

under development
System 02 | 3 Module | Garage | G

Gross Built Area:	1067 sq ft
Building Footprint:	583 sq ft
Interior Layout Area:	871 sq ft
Deck Area:	0 sq ft



The Backcountry Hut Company

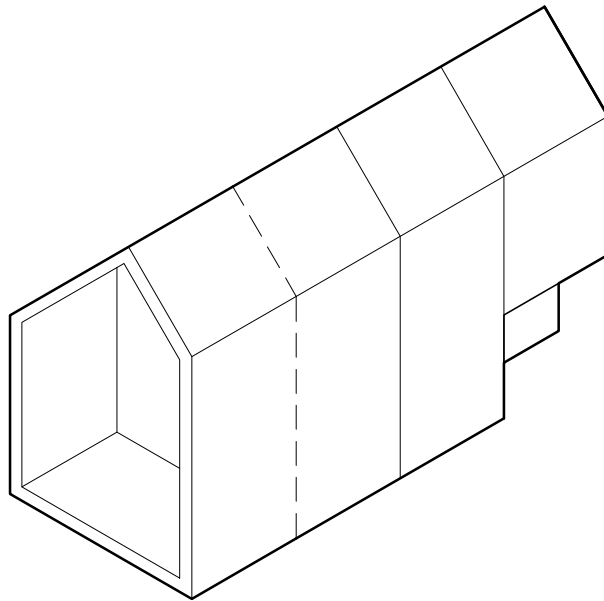

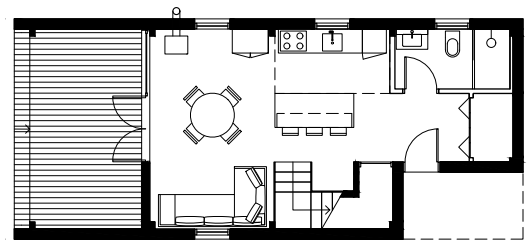
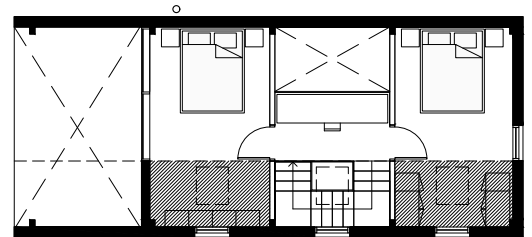

F

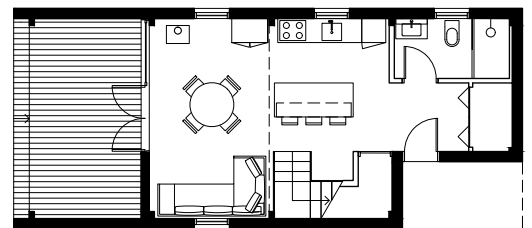
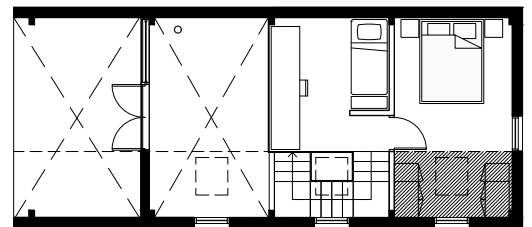

H

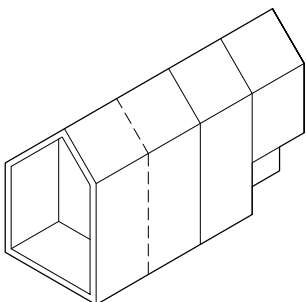



Flex Bays

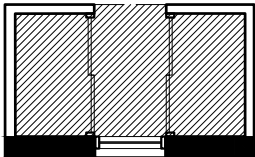

Closet + Bench

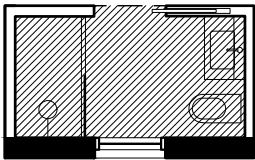

Bathroom

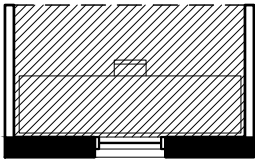

Study

Refer to flex bay appendix for complete selection of flex bay options

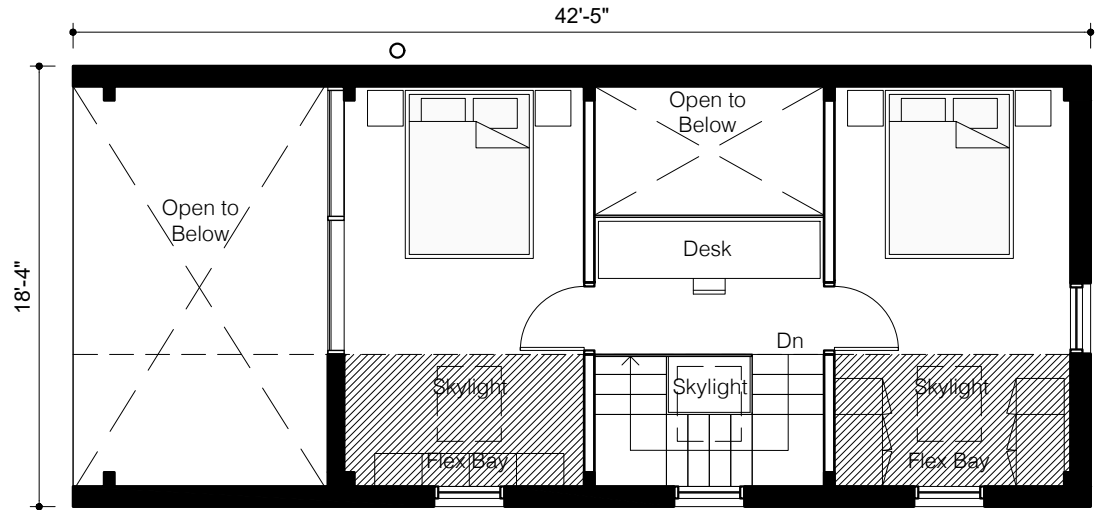

2nd Floor

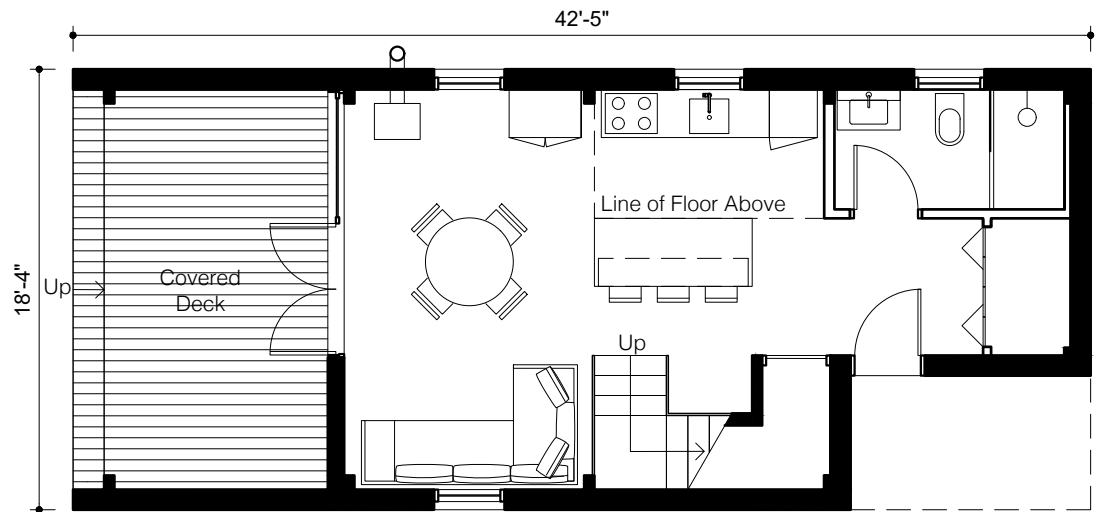

1st Floor

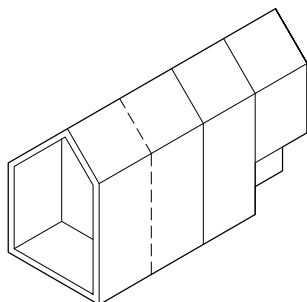

System 02 | 3 Module + Deck | F

Gross Built Area:	1205 sq ft
Building Footprint:	779 sq ft
Interior Layout Area:	828 sq ft
Deck Area:	174 sq ft



The Backcountry Hut Company

Flex Bays

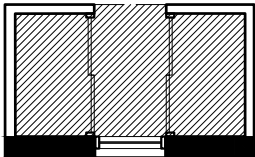

Closet + Bench

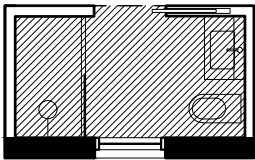

Bathroom

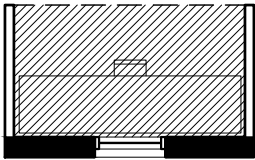

Study

Refer to flex bay appendix for complete selection of flex bay options

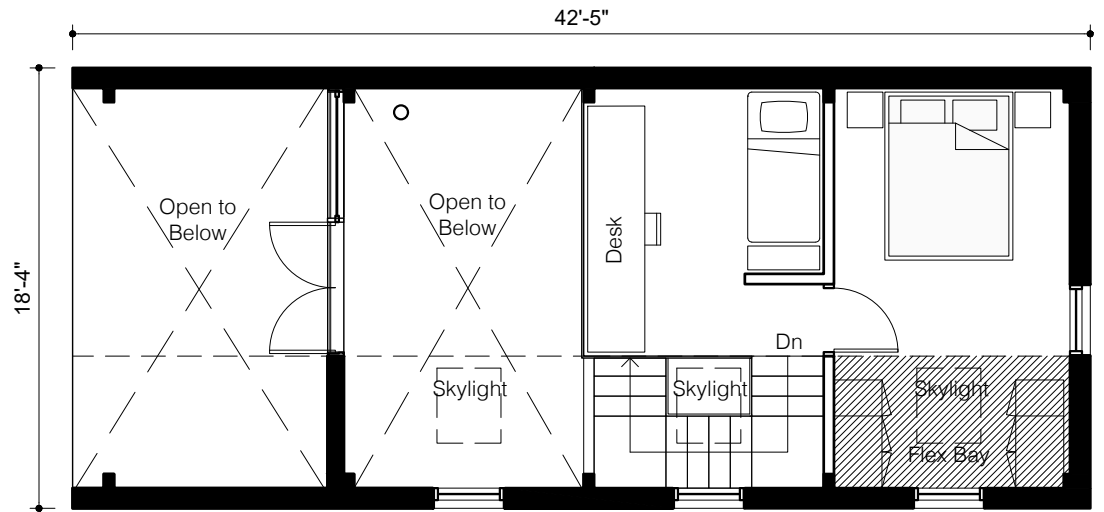

2nd Floor

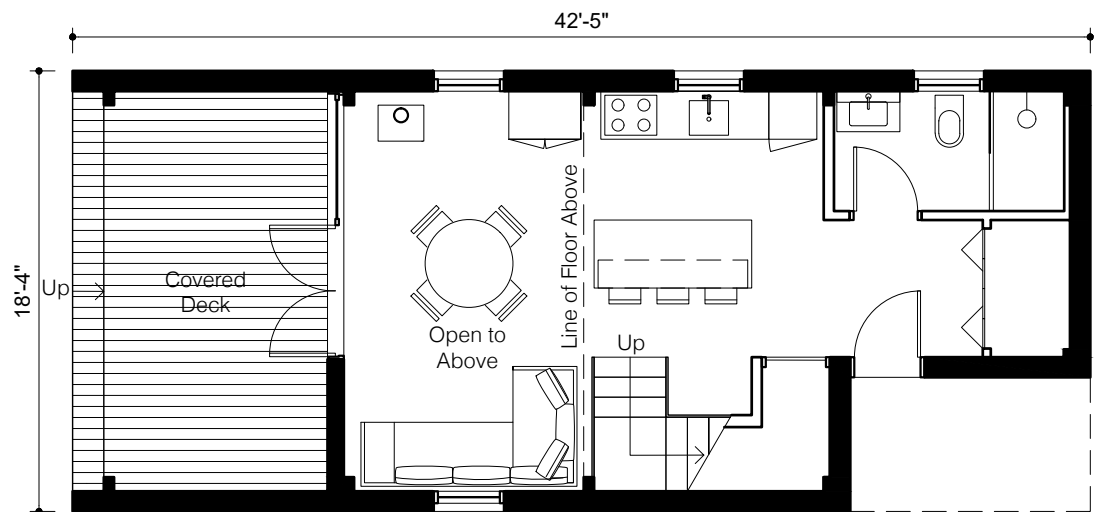

1st Floor

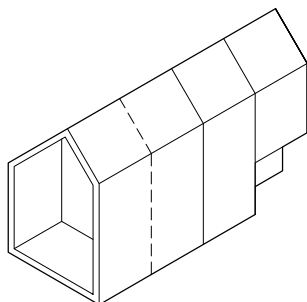

System 02 | 3 Module + Deck | H

Gross Built Area:	1091 sq ft
Building Footprint:	779 sq ft
Interior Layout Area:	716 sq ft
Deck Area:	174 sq ft



The Backcountry Hut Company

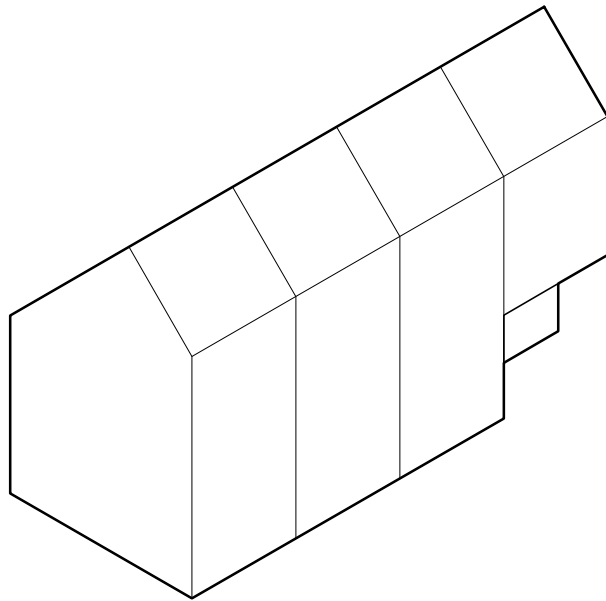



The Backcountry Hut Company

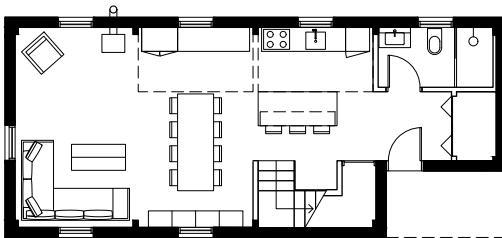
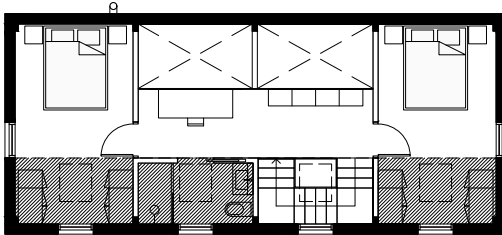

B

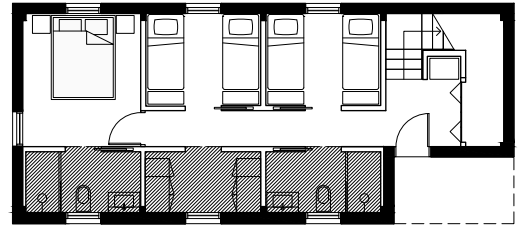
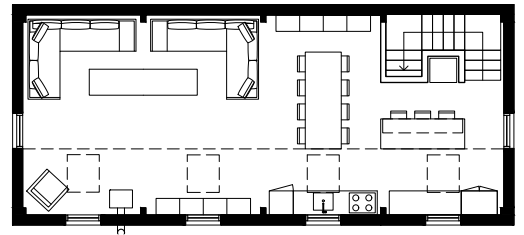

C

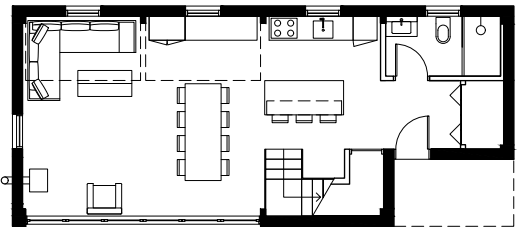
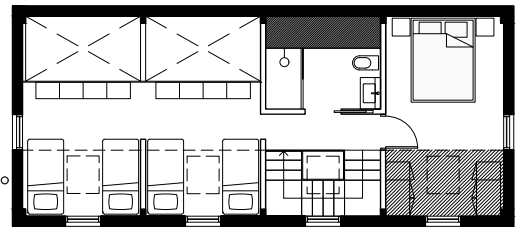

E

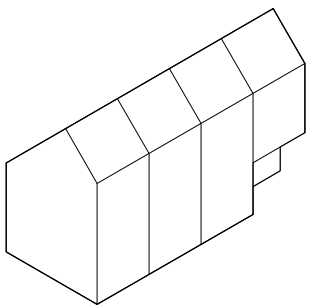



Flex Bays

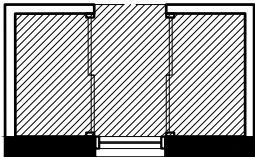

Closet + Bench

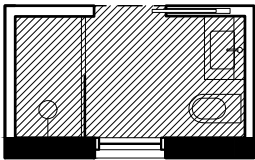

Bathroom

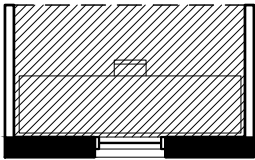

Study

Refer to flex bay appendix for complete selection of flex bay options

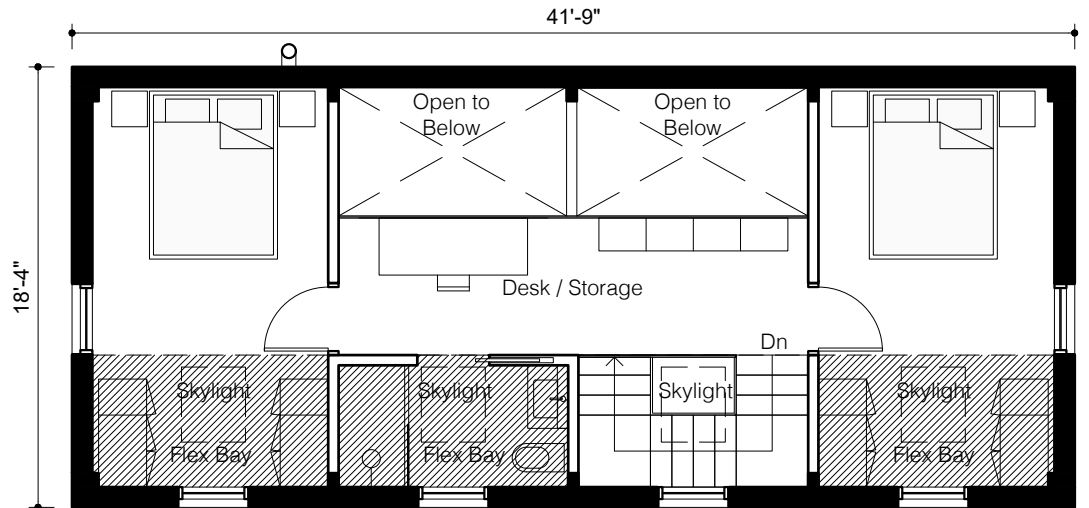

2nd Floor

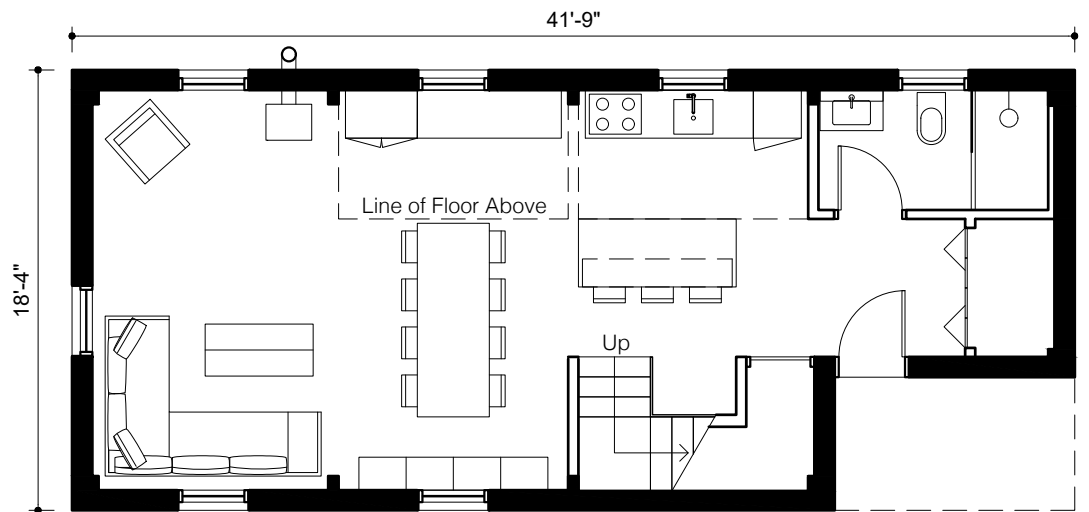

1st Floor

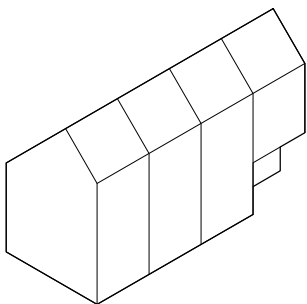

System 02 | 4 Module | B

Gross Built Area:	1319 sq ft
Building Footprint:	767 sq ft
Interior Layout Area:	1097 sq ft
Deck Area:	0 sq ft



The Backcountry Hut Company

Flex Bays

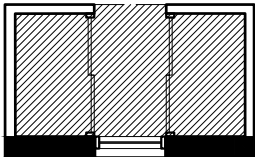

Closet + Bench

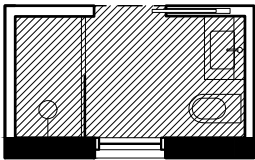

Bathroom

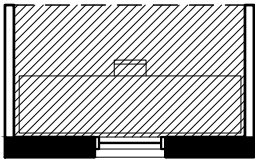

Study

Refer to flex bay appendix for complete selection of flex bay options

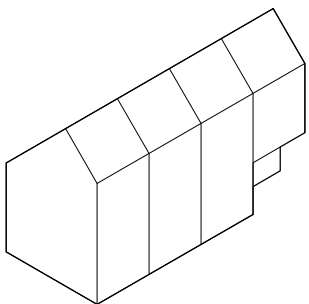
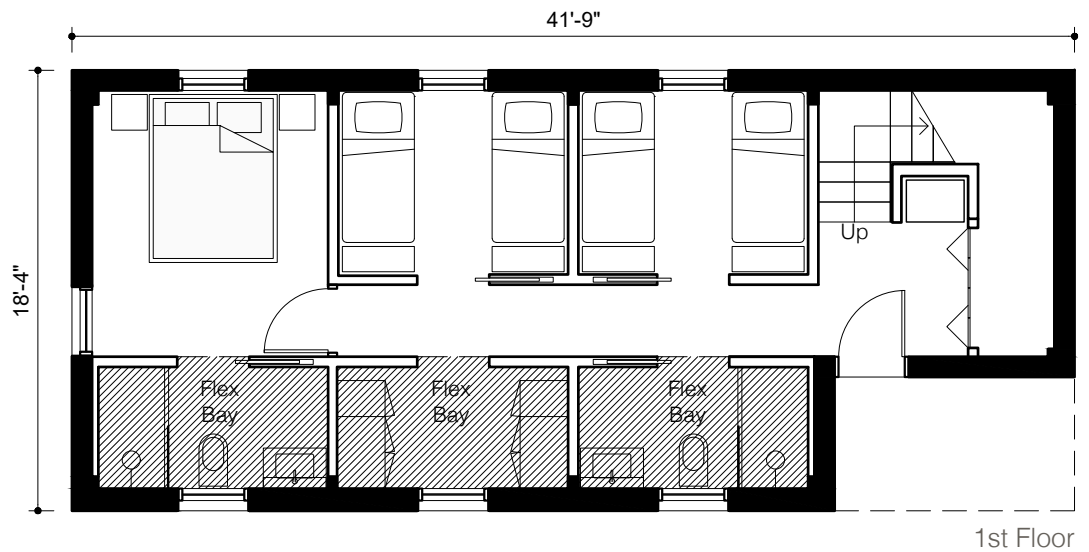
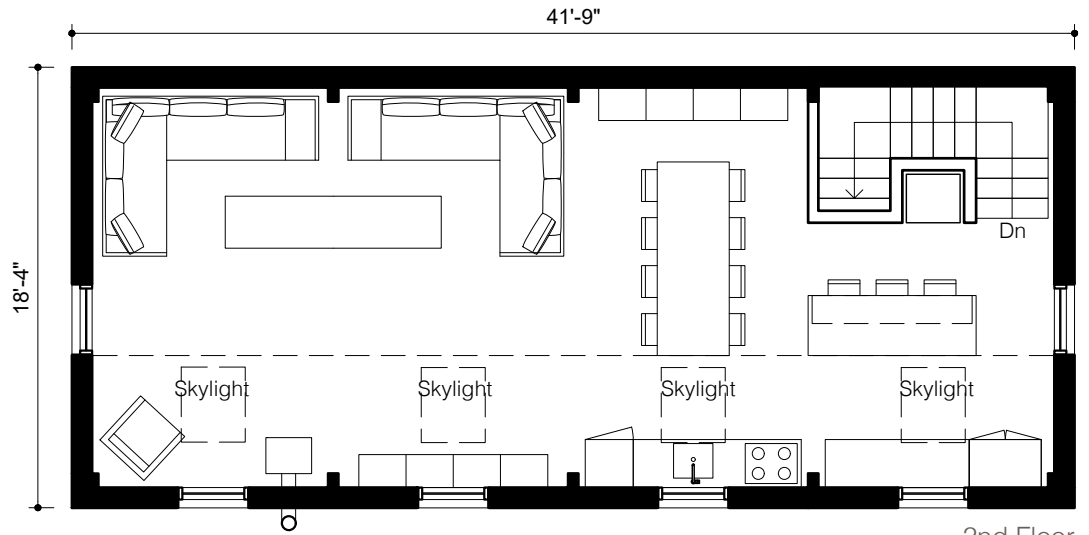

System 02 | 4 Module | C

Gross Built Area:	1434 sq ft
Building Footprint:	767 sq ft
Interior Layout Area:	1194 sq ft
Deck Area:	0 sq ft



The Backcountry Hut Company

Flex Bays

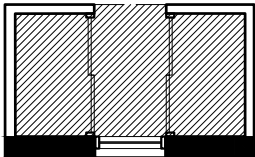

Closet + Bench

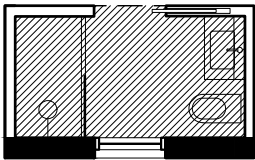

Bathroom

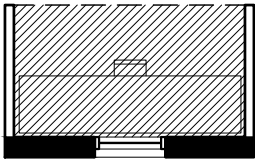

Study

Refer to flex bay appendix for complete selection of flex bay options

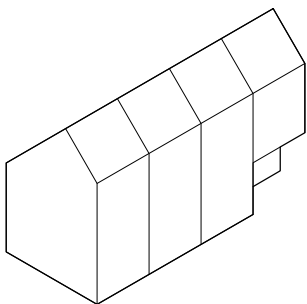
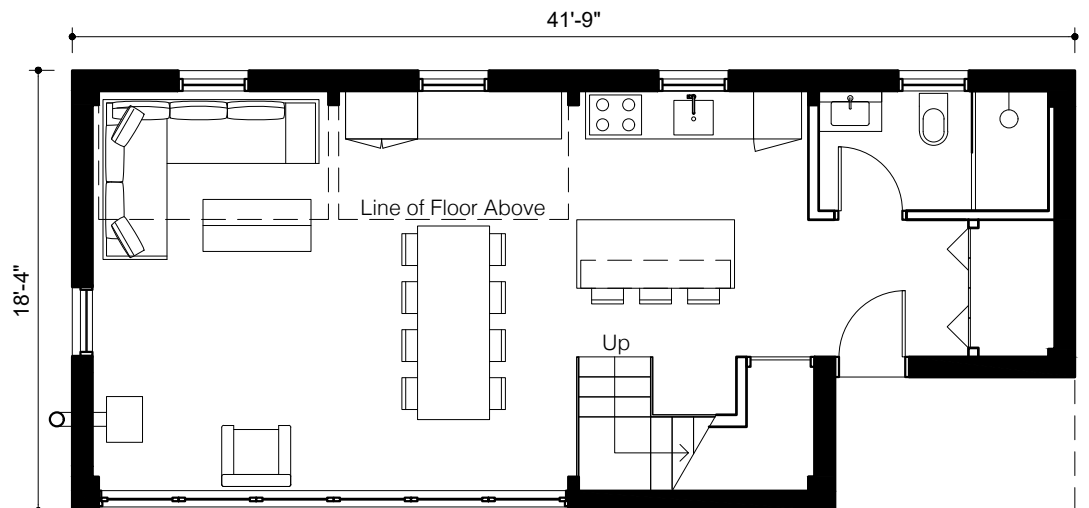
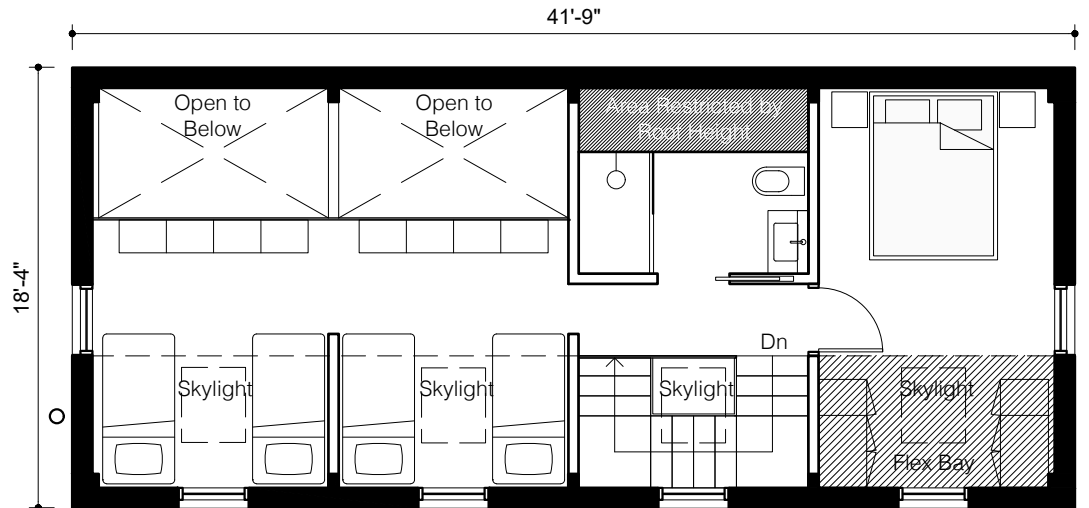

System 02 | 4 Module | E

Gross Built Area:	1316 sq ft
Building Footprint:	767 sq ft
Interior Layout Area:	1066 sq ft
Deck Area:	0 sq ft



The Backcountry Hut Company

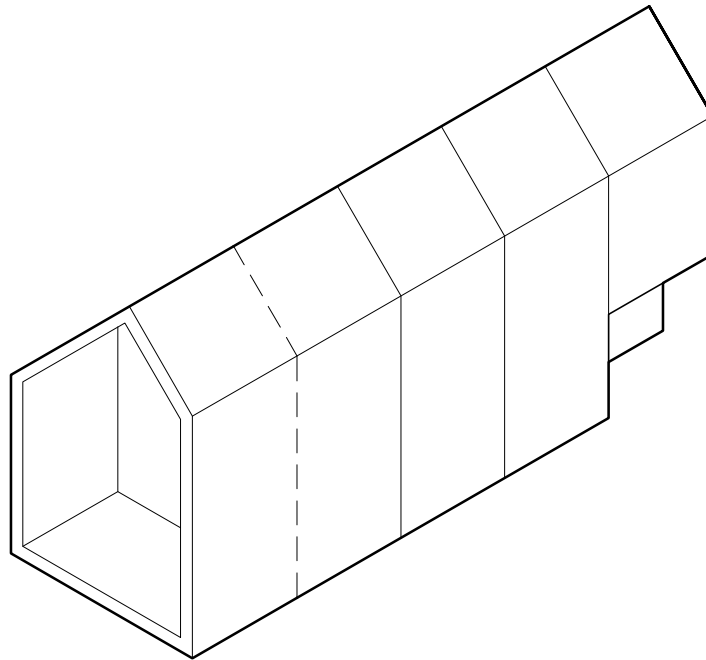

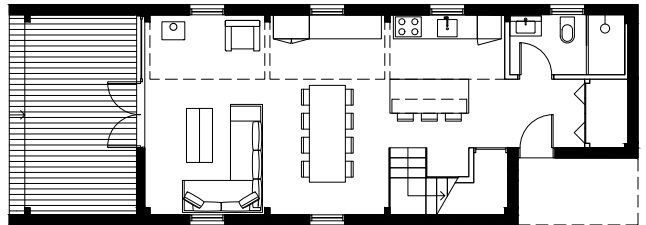
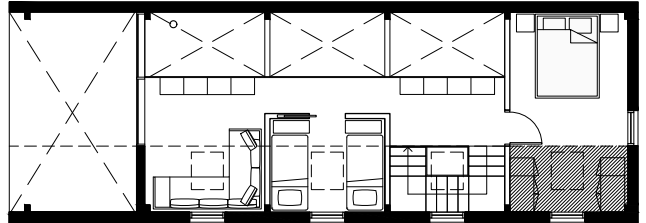

F

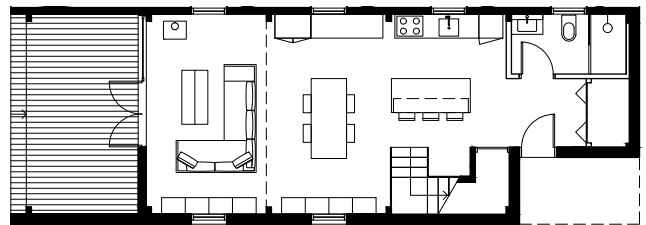
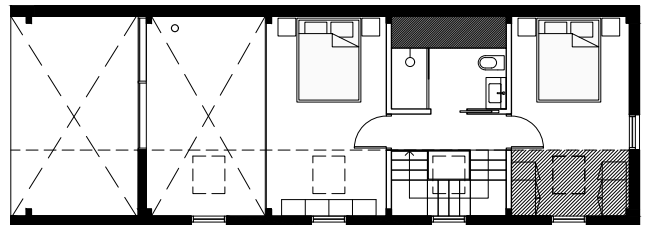

H

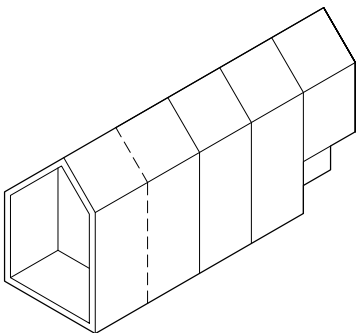



The Backcountry Hut Company

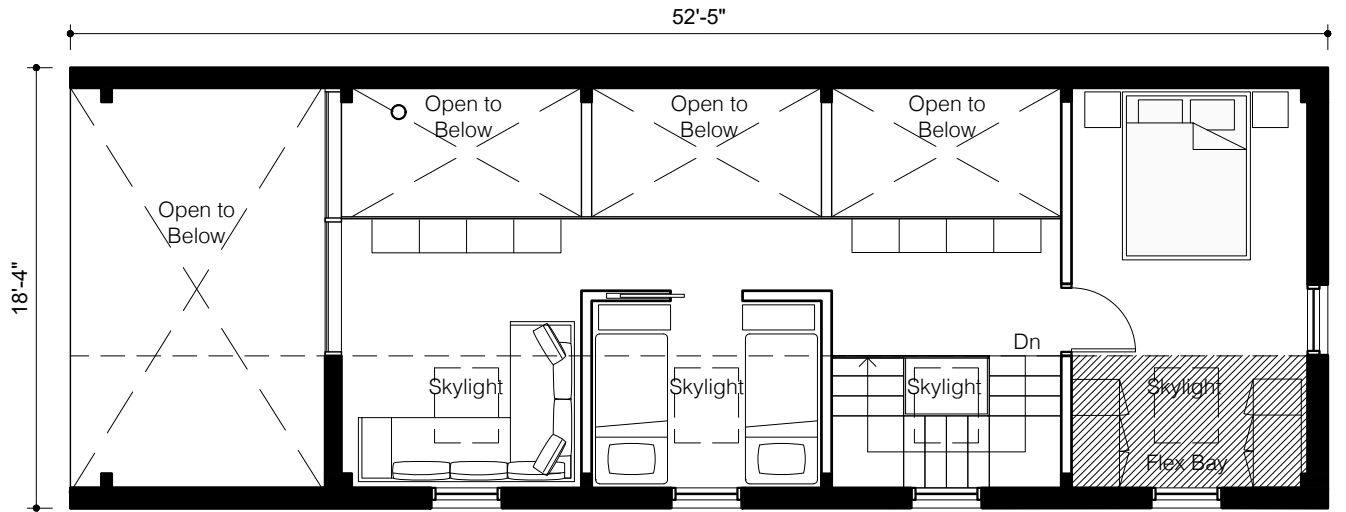

2nd Floor

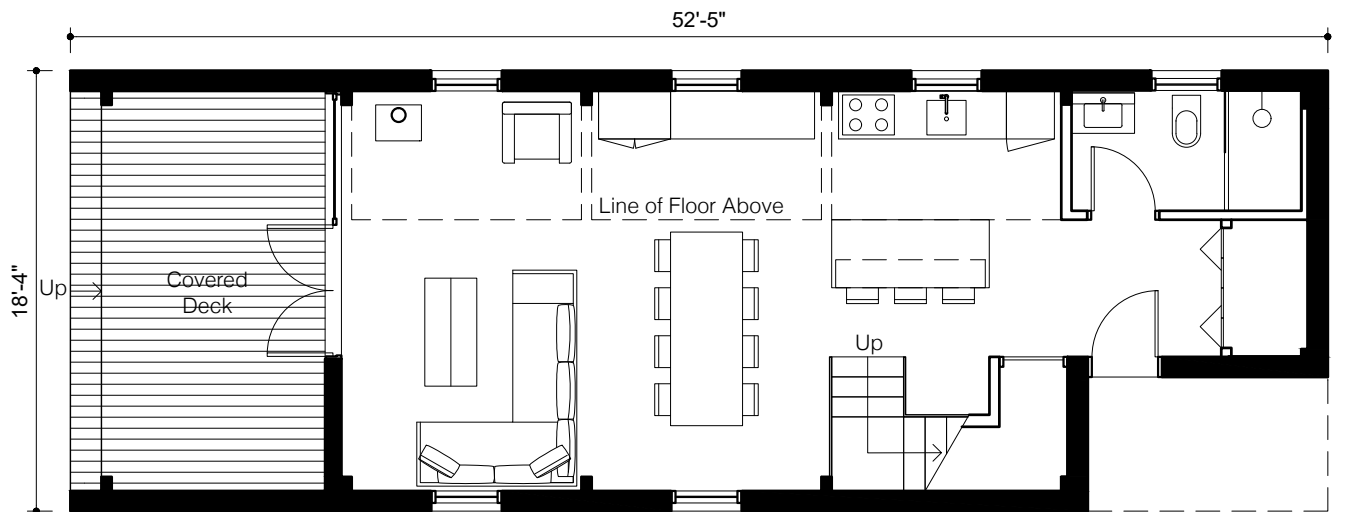

1st Floor

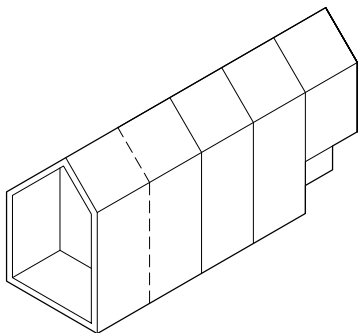

System 02 | 4 Module + Deck | F

Gross Built Area:	1462 sq ft
Building Footprint:	962 sq ft
Interior Layout Area:	1202 sq ft
Deck Area:	174 sq ft



The Backcountry Hut Company

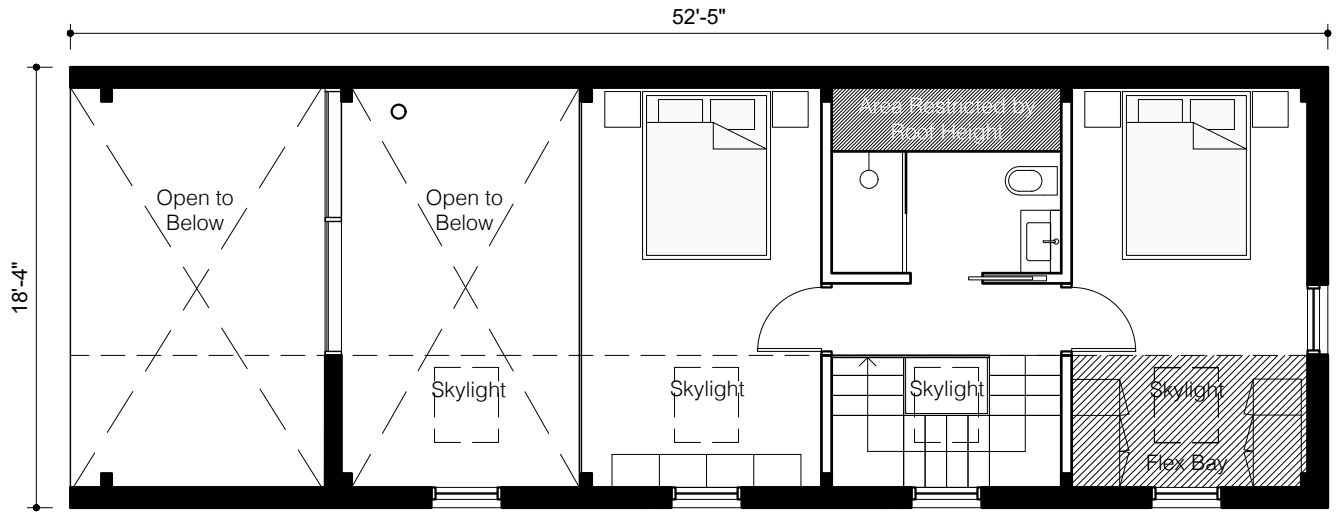

2nd Floor

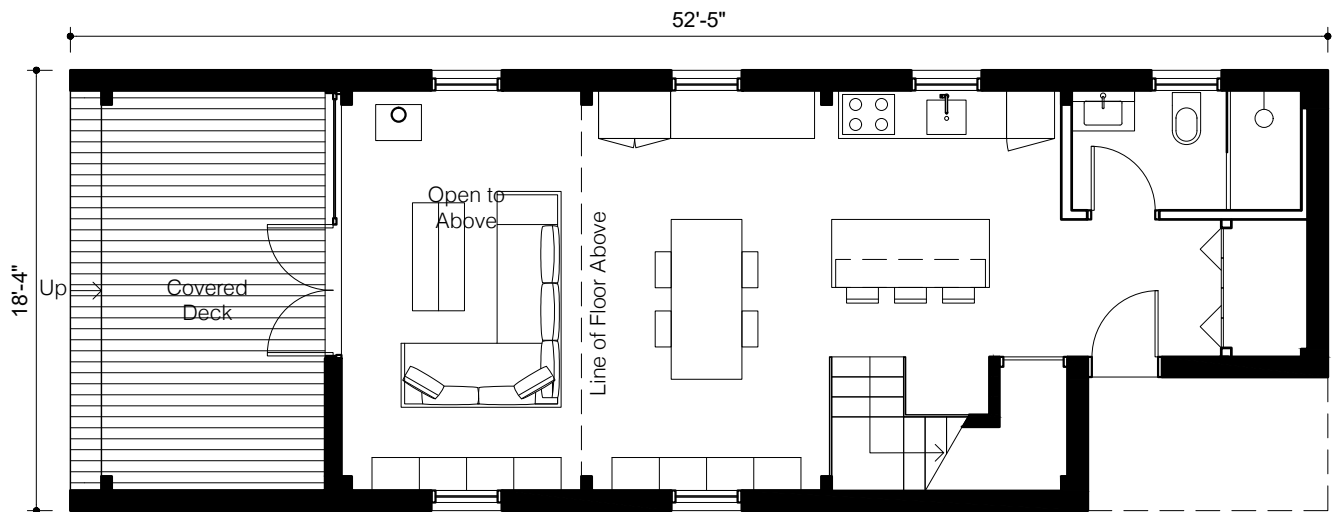

1st Floor

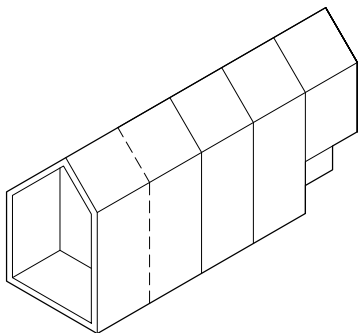

System 02 | 4 Module + Deck | H

Gross Built Area:	1458 sq ft
Building Footprint:	962 sq ft
Interior Layout Area:	1019 sq ft
Deck Area:	174 sq ft



The Backcountry Hut Company

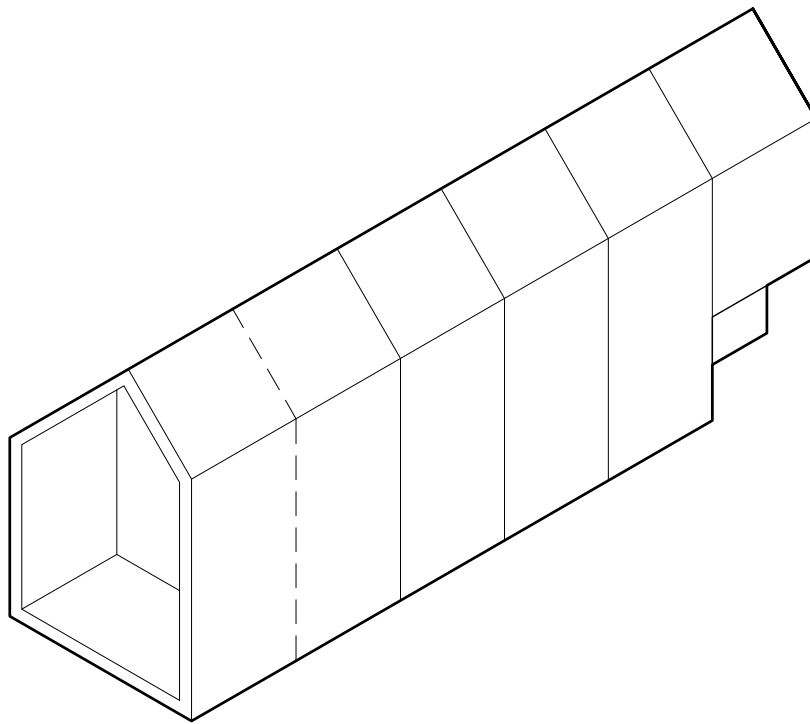

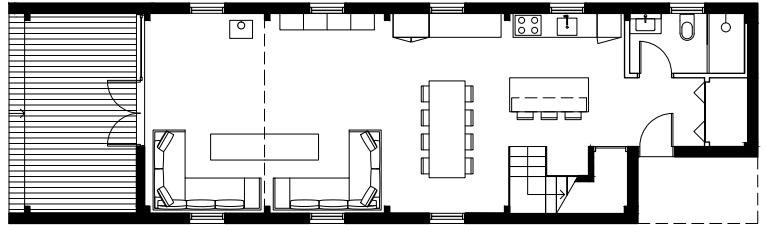
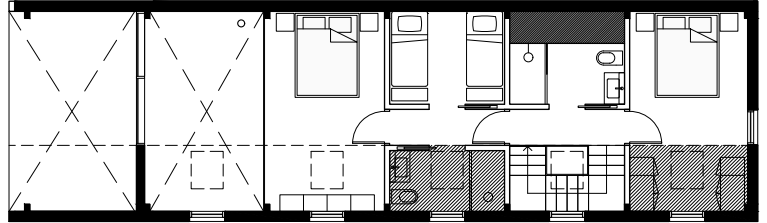

H

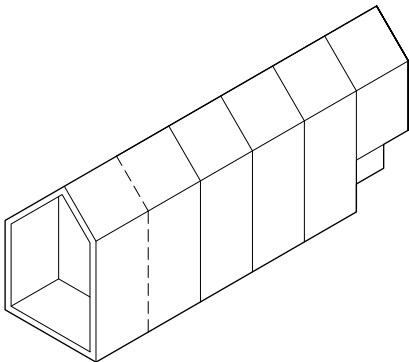



The Backcountry Hut Company

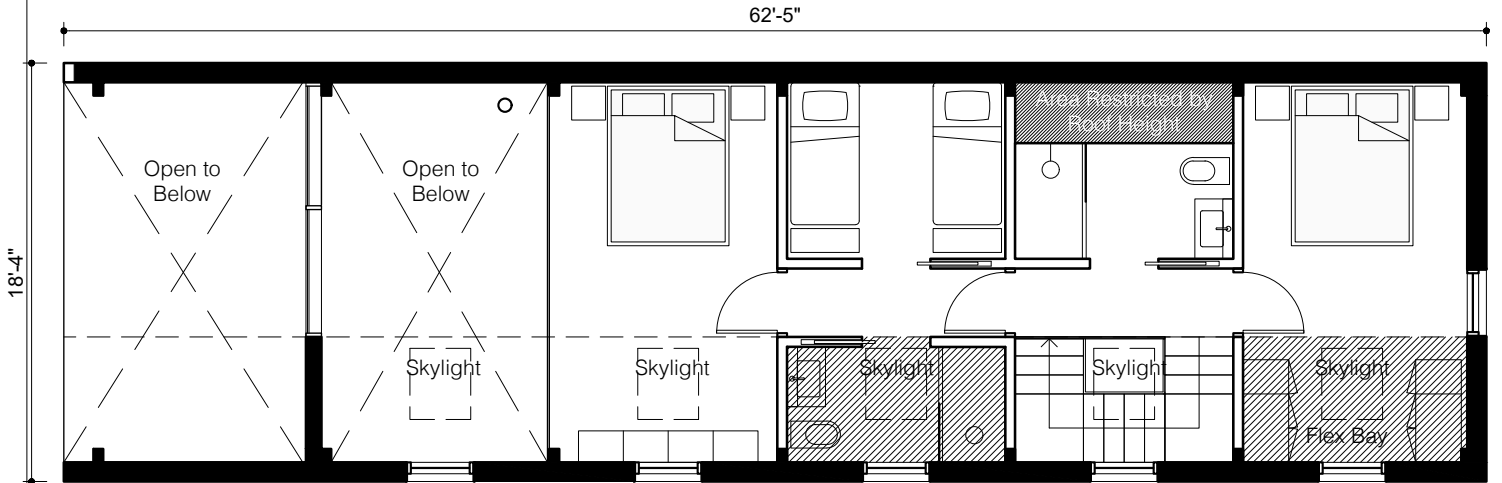

2nd Floor

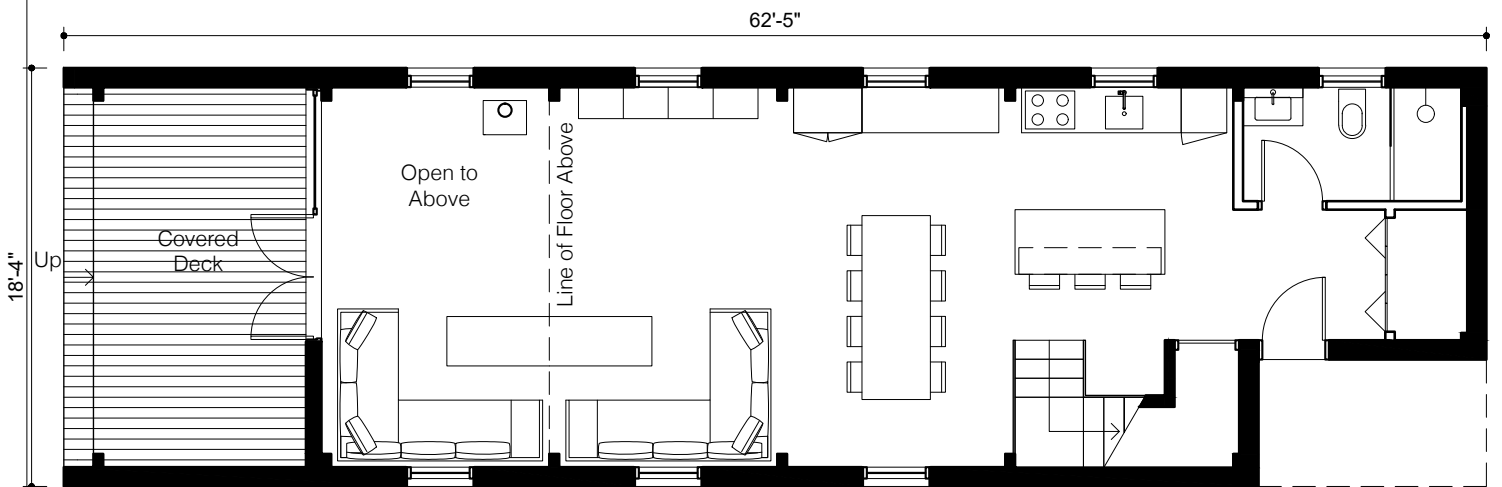

1st Floor

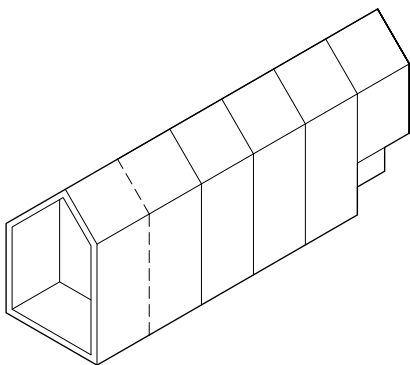

System 02 | 5 Module + Deck | H

Gross Built Area:	1826 sq ft
Building Footprint:	1145 sq ft
Interior Layout Area:	1366 sq ft
Deck Area:	174 sq ft



The Backcountry Hut Company

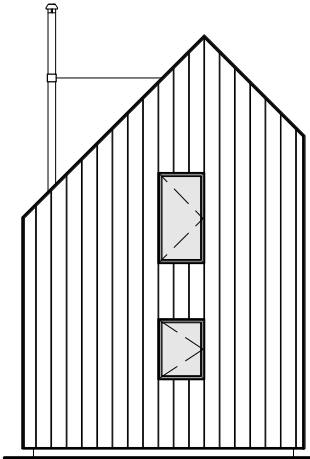

Solid End Wall

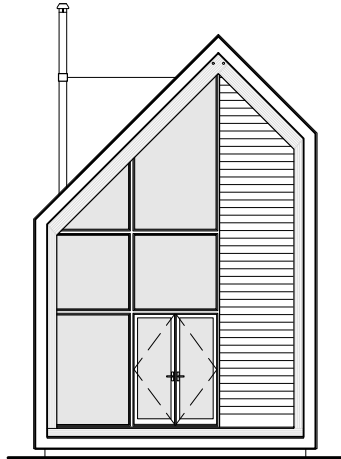

2/3 Glazing Wall (Swing Door)

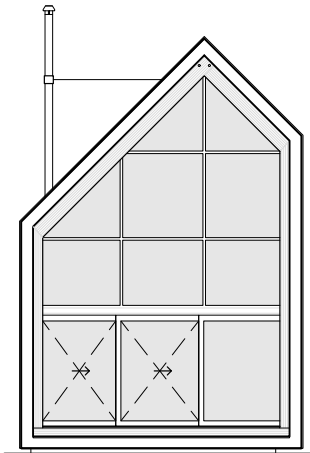

Full Glazing Wall (LiftSlide Door)

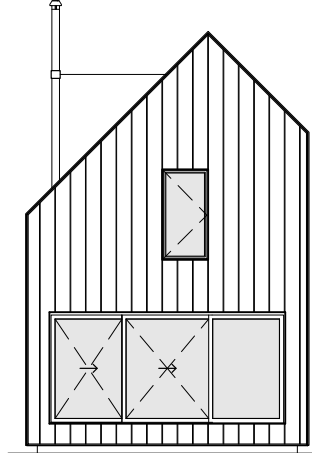

Solid End Wall (LiftSlide Door)

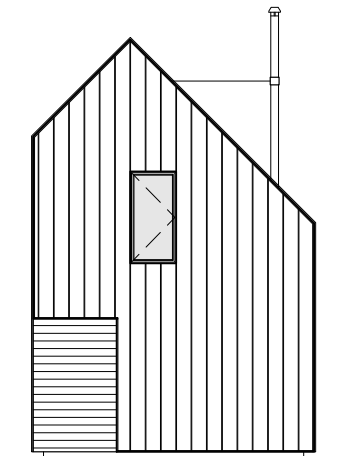

Entry Notch



The Backcountry Hut Company

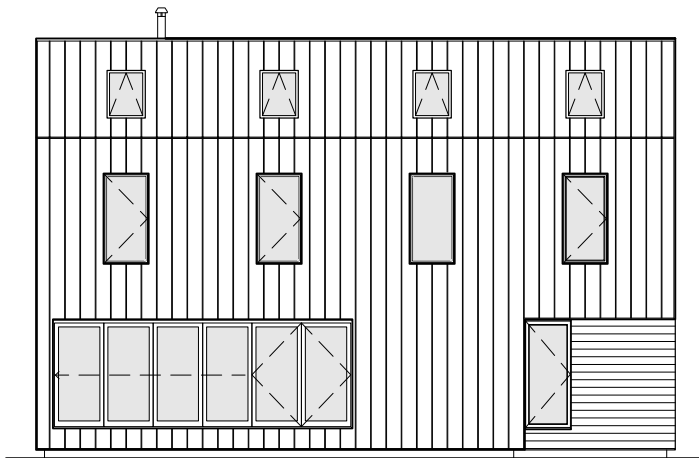

Multi-Panel Bifold Door on Tall Wall
System 02 | 4 Module | E



@thebackcountryhutcompany